

MODÜLER ELEKTRİK PANO SİSTEMLERİ

UNLIMITED **LIMITSİZ**

SOLUTIONS **ÇÖZÜM**

MODULAR ELECTRICAL ENCLOSURE SYSTEMS

NESEER
PANO

Neser modüler elektrik panoları çözümleriyle elektrik panonuzu istediğiniz gibi planlayın.



ELEKTRİK PANOLARINDA 3 BOYUT DA SİZİN KONTROLÜNÜZDE!

*3 DIMENSIONS IN ELECTRICAL ENCLOSURES
ARE UNDER YOUR CONTROL*

Plan your electrical enclosures the way you want with Neser modular electrical enclosure solutions.



TÜRKİYE'DEN DÜNYAYA!

ULUSLARARASI KALİTE STANDARTLARIYLA...

HAKKIMIZDA

Neser Pano Ltd. Şti, alçak gerilim panoları ürün gruplarında proje, mühendislik ve imalat hizmetleri sunmak üzere 2011 yılından itibaren Bursa'da hizmet vermeye başlamıştır.

Deneyimli kadrosuyla aldığı projelere başarılı imzalar atan ve hizmet verdiği müşterilerinin beğenisini ve güvenini kazanan firmamız, pano ve elektromontaj konusunda tercih edilen bir marka haline gelmiştir. Hizmet verdiğimiz alanlar arasında endüstriyel tesisler, sağlık kuruluşları, eğitim binaları, iş merkezleri, oteller ve konutlar bulunmaktadır.

Sektördeki tüm yenilikleri takip ederek, iş ortaklarımızın ihtiyaç ve istekleri doğrultusunda projelerin her biri kendi içerisinde değerlendirilmekte, uygun çözüm sonuçları müşterilerimiz ile paylaşılmaktadır. Sürdürülebilir gelişim ve yüksek hizmet kalitesi tüm uygulamalarımızın temelini oluşturmaktadır.

Daha fazla bilgi için, internet sitemiz www.neserpano.com.tr sayfamızı ziyaret edebilirsiniz. proje@neserpano.com.tr mail adresimize yapacağınız taleplere destek olmaktan memnuniyet duyuyoruz.

ABOUT US

Neser Pano Ltd. Şti has started to serve in Bursa since 2011 in order to provide project, engineering and manufacturing services in low voltage panels product groups.

We have completed successful projects with our experienced team and gained the appreciation and trust of our customers. Our company has become a preferred supplier and brand in panels and in it's components. The areas we serve include industrial facilities, health institutions, educational buildings, business centers, hotels and residences.

By following all the innovations in the sector, each project is evaluated in line with the needs and requests of our business partners, and appropriate solution results are shared with our customers. Sustainable development and high service quality form the basis of all our practices.

For further information, you can visit our website www.neserpano.com.tr. We will be pleased to support your requests to our project@neserpano.com.tr e-mail address.

ÜRETİM KALİTESİ GÜVENCE ALTINDA!

KALİTE / QUALITY

Neser Pano üretim faaliyetlerini ISO 9001 kalite yönetim sistemine uygun şekilde sürdürmektedir. Alçak gerilim panoları LVT (Low Voltage Directive) 2006/95/EC uygun olarak üretilmektedir. Panolarımız IP-54 ve IP-55 standartlarını taşımaktadır.

Neser Pano continues its production activities in accordance with the ISO 9001 quality management system. Low voltage panels are produced in accordance with LVT (Low Voltage Directive) 2006/95 / EC. Our panels carry the standards of IP-54 and IP-55.



DİKİLİ TİP MODÜLER PANOLAR

STAND ALONE MODULAR ENCLOSURES



DKP çelikten üretilen panolar, kullanım amacı bakımından iki farklı tipte üretilmektedir:

- Dikili Tip Dahili Modüler Pano
- Dikili Tip Harici Modüler Pano

Dış parçaları epoksi polyester toz boya (RAL 7032 / RAL 7035) ve iç aksamı galvaniz saçtan üretilmiş olan ürünümüz, IP55, IP41 standartlarında üretilmektedir.



Standing type panels made of DKP steel are produced in two different types in terms of intended use:

- Standing Type Internal Modular Panel
- Free Standing Type External Modular Panel

While the outer parts are covered with epoxy polyester powder paint (RAL 7032 / RAL 7035), the inner parts are made of galvanized sheet. Our products can be produced in IP55, IP41 standards.

NESER PANO STANDARTLARINA GÖRE

KESİNLİKLE SÜRDÜRÜLEBİLİR

ABSOLUTELY SUSTAINABLE ACCORDING TO NESER PANO STANDARDS

7

Evrensel kalite anlayışımız perspektifinde
“sürdürülebilirlik” temel vizyonumuzun olmazsa olmazı!

*In the perspective of our universal understanding of quality,
“sustainability” is an essential nostri of our basic vision!*

Modüler elektrik panolarını üretirken sürdürülebilirlik anlayışımız dahilinde 7 ana farkımızı koruyor, yenileniyor, geliştiriliyoruz!

While producing modular electrical panels, we preserve, renew and develop our 7 main differences within the framework of our sustainability understanding.



- 1 ÜRETİM KALİTESİ *PRODUCTION QUALITY*
- 2 DOĞRU FİYAT *RIGHT PRICE*
- 3 TAM ZAMANINDA TESLİMAT *JUST IN TIME DELIVERY*
- 4 ÇÖZÜM ÜRETME *GENERATING SOLUTION*
- 5 ÜRÜN GELİŞTİRME *PRODUCT DEVELOPMENT*
- 6 ÇEVREYE SAYGILI İMALAT *ENVIRONMENTALLY FRIENDLY MANUFACTURING*
- 7 GELİŞİM VE EĞİTİM *DEVELOPMENT AND TRAINING*

TEKNİK DETAYLAR

TECHNICAL DETAILS

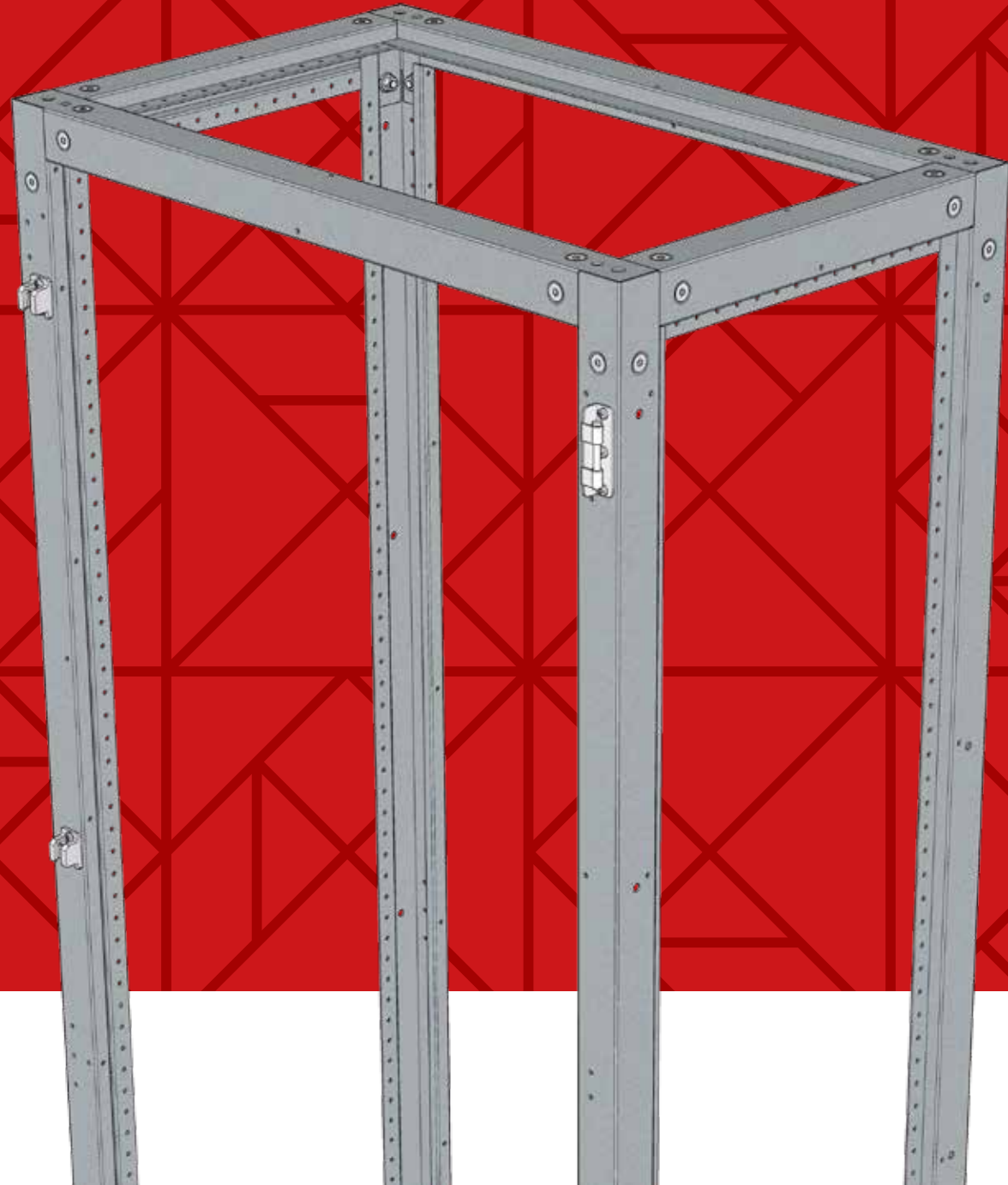

AÇIKLAMALAR / EXPLANATIONS

Dikili Tip Modüler Panolar endüstri, enerji, elektronik, otomasyon ve telekomünikasyon gibi farklı alanlarda kullanılmaktadır. Gerek çevresel koşullar gerekse özel taleplere bağlı olarak farklı boyut, malzeme, kaplama ve aksesuar seçenekler sunulmaktadır.

Koruma Sınıfı

IP55

Normal şartlar altında sıcaklık aralığı

-15 °C ile

+40 °C arası

Anma İşletme Gerilimi (Ue)

400V

Malzeme

2.0 mm sac

Renk

RAL7035

Protection Class

IP55

Temperature range under normal conditions

from -15 °C to

+40 °C

Rated Operational Voltage (Ue)

400V

Material

2.0 mm sac

Color

RAL7035

Standing Type Modular Panels are used in different fields such as industry, energy, electronics, automation and telecommunication. Different size, material, coating and accessory options are offered depending on both environmental conditions and special demands.

STANDART İÇERİK / STANDART CONFIGURATION

Modüler Karkas
Modular Frame



Üst Kapak
Top Plate

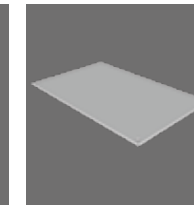

Baza Takımı
Base Set

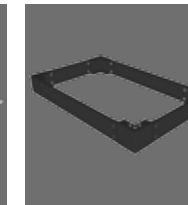

Sabit Kapaklar
Side Panels

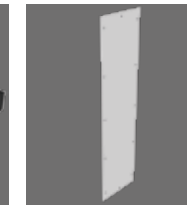

Ön Kapı
Front Door



Montaj Plakası
Mounting Plate





OPSİYONEL İÇERİK / *OPTIONAL CONFIGURATION*

Ön Kapı Seçenekleri
Front Door Alternatives

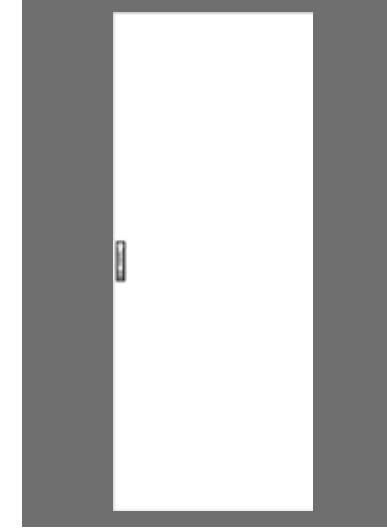

STANDART
Standard



CAMLI
Glazed

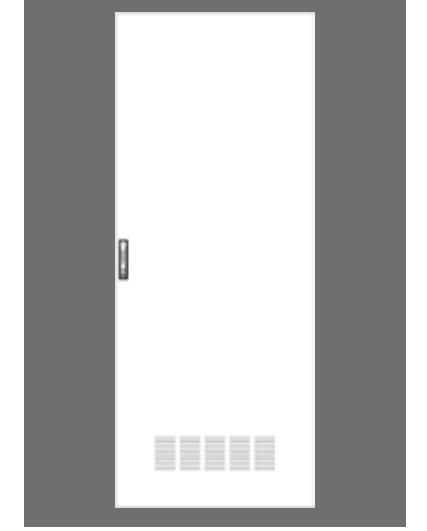

HAVALANDIRMALI
Vented

Örtü Plakaları
Cover Plates



Parçalı Montaj Plakası
Partial Mounting Plate

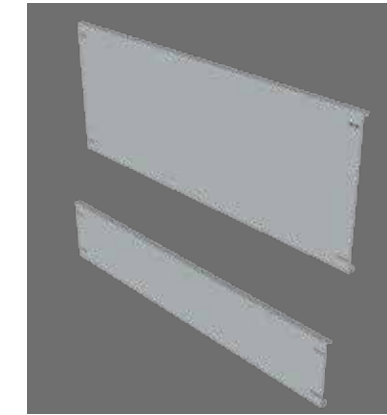

MODÜLER ELEKTRİK PANOSU ÇÖZÜM KOMPONENTLERİ

MODULAR ELECTRICAL ENCLOSURES SOLUTIONS COMPONENTS

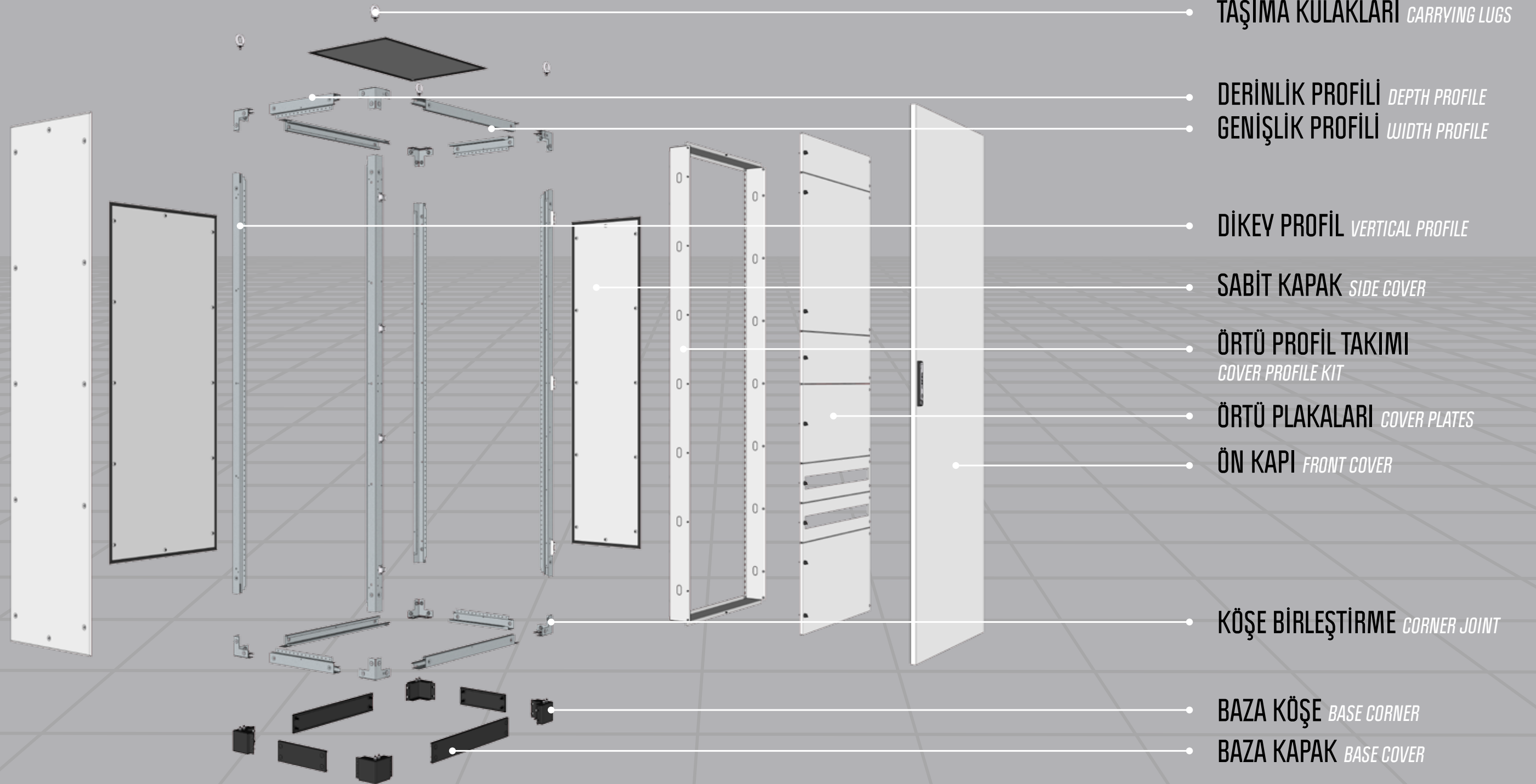

KARKAS FRAME



Malzeme: 2.0 mm galvanizli sac

Pano karkası 4 adet dikey profil, 8 adet yatay profil, 8 takım köşe birleştirme parçası ve 48 adet M8 imbus civata-somun elemanından oluşur.

Material: 2.0mm galvanized sheet

The frame of the panel consists of 4 vertical profiles, 8 horizontal profiles, 8 sets of corner joints and 48 M8 bolt-nut elements.

MODÜLER DİKİLİ TİP KARKAS			
MODULAR ENCLOSURES FRAME			
ÜRÜN KODU	EN (mm)	BOY (mm)	DERİNLİK (mm)
PRODUCT CODE	WIDTH (mm)	LENGHT (mm)	DEPTH (mm)
NP-MDK-4014040	400	1400	400
NP-MDK-4014050			500
NP-MDK-4014060			600
NP-MDK-4014070			700
NP-MDK-4014080			800
NP-MDK-4016040		1600	400
NP-MDK-4016050			500
NP-MDK-4016060			600
NP-MDK-4016070			700
NP-MDK-4016080			800
NP-MDK-4018040		1800	400
NP-MDK-4018050			500
NP-MDK-4018060			600
NP-MDK-4018070			700
NP-MDK-4018080			800
NP-MDK-4020040		2000	400
NP-MDK-4020050			500
NP-MDK-4020060			600
NP-MDK-4020070			700
NP-MDK-4020080			800
NP-MDK-4020090		900	
NP-MDK-40200100		1000	
NP-MDK-5014040	500	1400	400
NP-MDK-5014050			500
NP-MDK-5014060			600
NP-MDK-5014070			700
NP-MDK-5014080			800
NP-MDK-5016040		1600	400
NP-MDK-5016050			500
NP-MDK-5016060			600
NP-MDK-5016070			700
NP-MDK-5016080			800
NP-MDK-5018040		1800	400
NP-MDK-5018050			500
NP-MDK-5018060			600
NP-MDK-5018070			700
NP-MDK-5018080			800
NP-MDK-5020040		2000	400
NP-MDK-5020050			500
NP-MDK-5020060			600
NP-MDK-5020070			700
NP-MDK-5020080			800
NP-MDK-5020090		900	
NP-MDK-50200100		1000	

MODÜLER DİKİLİ TİP KARKAS			
MODULAR ENCLOSURES FRAME			
ÜRÜN KODU	EN (mm)	BOY (mm)	DERİNLİK (mm)
PRODUCT CODE	WIDTH (mm)	LENGHT (mm)	DEPTH (mm)
NP-MDK-6014040	600	1400	400
NP-MDK-6014050			500
NP-MDK-6014060			600
NP-MDK-6014070			700
NP-MDK-6014080			800
NP-MDK-6016040		1600	400
NP-MDK-6016050			500
NP-MDK-6016060			600
NP-MDK-6016070			700
NP-MDK-6016080			800
NP-MDK-6018040		1800	400
NP-MDK-6018050			500
NP-MDK-6018060			600
NP-MDK-6018070			700
NP-MDK-6018080			800
NP-MDK-6020040		2000	400
NP-MDK-6020050			500
NP-MDK-6020060			600
NP-MDK-6020070			700
NP-MDK-6020080			800
NP-MDK-6020070		900	
NP-MDK-6020080		1000	
NP-MDK-7014040	700	1400	400
NP-MDK-7014050			500
NP-MDK-7014060			600
NP-MDK-7014070			700
NP-MDK-7014080			800
NP-MDK-7016040		1600	400
NP-MDK-7016050			500
NP-MDK-7016060			600
NP-MDK-7016070			700
NP-MDK-7016080			800
NP-MDK-7018040		1800	400
NP-MDK-7018050			500
NP-MDK-7018060			600
NP-MDK-7018070			700
NP-MDK-7018080			800
NP-MDK-7020040		2000	400
NP-MDK-7020050			500
NP-MDK-7020060			600
NP-MDK-7020070			700
NP-MDK-7020080			800
NP-MDK-7020090		900	
NP-MDK-70200100		1000	

MODÜLER DİKİLİ TİP KARKAS			
MODULAR ENCLOSURES FRAME			
ÜRÜN KODU	EN (mm)	BOY (mm)	DERİNLİK (mm)
PRODUCT CODE	WIDTH (mm)	LENGHT (mm)	DEPTH (mm)
NP-MDK-8014040	800	1400	400
NP-MDK-8014050			500
NP-MDK-8014060			600
NP-MDK-8014070			700
NP-MDK-8014080			800
NP-MDK-8016040		1600	400
NP-MDK-8016050			500
NP-MDK-8016060			600
NP-MDK-8016070			700
NP-MDK-8016080			800
NP-MDK-8018040		1800	400
NP-MDK-8018050			500
NP-MDK-8018060			600
NP-MDK-8018070			700
NP-MDK-8018080			800
NP-MDK-8020040		2000	400
NP-MDK-8020050			500
NP-MDK-8020060			600
NP-MDK-8020070			700
NP-MDK-8020080			800
NP-MDK-8020090		900	
NP-MDK-80200100		1000	

MODÜLER DİKİLİ TİP KARKAS İÇERİĞİ			
MODULAR ENCLOSURES FRAME CONTENT			
ÜRÜN KODU		MIKTAR	
PRODUCT CODE		QUANTITY	UNIT
DİKEY PROFİL	VERTICAL CORNER	4	Ad
DERİNLİK PROFİLİ	DEPTH PROFILE	4	Ad
GENİŞLİK PROFİLİ	WIDTH PROFILE	4	Ad
KÖŞE BİRLEŞTİRME TAKIMI	CORNER JOINING SET	8	Ad
M8x20 İMBUS CİVATA	M8x20 İMBUS BOLT	48	Ad
RONDELA		48	Ad



BURSA'DAN DÜNYA'YA TÜRKİYE'NİN
ELEKTRİK PANOLARI MARKASI



FROM BURSA TO THE WORLD TURKEY'S
ELECTRICAL ENCLOSURE BRAND

SABİT KAPAK

SIDE COVER



Malzeme: 1.2 mm DKP sac

Sabit kapaklar M5x12 taptite cıvatalar kullanılarak, modüler karkasa monte edilmektedir.

Material: 1.2 mm DKP sheet

Fixed covers are mounted to modular carcass using M5x12 taptite bolts.

SABİT KAPAK		
SIDE COVER		
ÜRÜN KODU	EN (mm)	BOY (mm)
PRODUCT CODE	WIDTH (mm)	LENGHT (mm)
NP-SK40140	400	1400
NP-SK40160		1600
NP-SK40180		1800
NP-SK40200		2000
NP-SK50140	500	1400
NP-SK50160		1600
NP-SK50180		1800
NP-SK50200		2000
NP-SK60140	600	1400
NP-SK60160		1600
NP-SK60180		1800
NP-SK60200		2000
NP-SK70140	700	1400
NP-SK70160		1600
NP-SK70180		1800
NP-SK70200		2000
NP-SK80140	800	1400
NP-SK80160		1600
NP-SK80180		1800
NP-SK80200		2000
NP-SK90140	900	1400
NP-SK90160		1600
NP-SK90180		1800
NP-SK90200		2000
NP-SK100140	1000	1400
NP-SK100160		1600
NP-SK100180		1800
NP-SK100200		2000
NP-SK110140	1100	1400
NP-SK110160		1600
NP-SK110180		1800
NP-SK110200		2000
NP-SK120140	1200	1400
NP-SK120160		1600
NP-SK120180		1800
NP-SK120200		2000



SABİT KAPAK İÇERİĞİ			
SIDE COVER CONTENT			
ÜRÜN KODU		MIKTAR	BİRİM
PRODUCT CODE		QUANTITY	UNIT
SABİT KAPAK	SIDE DOOR	1	Ad
M5x12YSB TAPTITE CİVATA	BOLT IN TAPITE	Min 10	Ad

ÇEVREYE SAYGI, GELECEĞE SAYGI...

*RESPECT FOR THE ENVIRONMENT,
RESPECT FOR THE FUTURE*

Modüler elektrik panoları üretiminde yaşam için hiç değişmeyen denge!

*Unchanging balance for life in the productions of modular
electrical enclosures*

Üretimin her safhasında, dünya gerçekleri ışığında doğru ve etkili çevre politikaları uyguluyoruz!



At every stage of production, we implement correct and effective environmental policies in the light of world realities.

1

KAYNAKLARI KORUYORUZ!
WE PROTECT RESOURCES

2

DOĞRU ATIK YÖNETİMİ UYGULUYORUZ!
WE APPLY THE CORRECT WASTE MANAGEMENT

3

VERİMLİLİĞİ ESAS KILIYORUZ!
WE FOCUS OF EFFICIENCY

4

KARBON AYAK İZİMİZİ KÜÇÜLTÜYORUZ!
WE ARE REDUCING OUR CARBON FOOTPRINT

ÖN KAPAK FRONT DOOR



Malzeme: 2.0 mm DKP sac

Kapıda, sızdırmazlık bölgesinin dışına yerleştirilmiş en az bir kilit bulunmaktadır. 3 adet gizli menteşe kapının sağ veya sol açılmasını sağlayacak şekilde yerleştirilir. Tüm kapılar iki taraflı olarak kullanılabilir. Kapıda toza ve sıvıya karşı sızdırmazlığı sağlamak için conta kullanılır. Kapı destek profilleri mukavemeti artırmak ve elektrik komponentlerinin montajlanmasını sağlamak amacıyla kapı iç kısmına monte edilir. Gizli kapı menteşeleri, kapının 130 derece açılmasını sağlar. 4 farklı tipte kapı bulunmaktadır.

Material: 2.0 mm DKP sheet

The door is equipped with minimum one lock placed outside the sealing zone. 3 concealed hinges are placed so that the door can be opened to the right or left. All doors can be used on both sides. Gaskets are used to seal the door against dust and liquid contamination. Door support profiles are mounted inside the door in order to increase strength and to ensure the assembly of electrical components. Concealed door hinges allow the door to be opened 130 degrees. There are 4 different types of d

ÖN KAPAK		
FRONT DOOR		
ÜRÜN KODU	EN (mm)	BOY (mm)
PRODUCT CODE	WIDTH (mm)	LENGHT (mm)
NP-OK40140	400	1400
NP-OK-40160		1600
NP-OK40180		1800
NP-OK40200		2000
NP-OK50140	500	1400
NP-OK50160		1600
NP-OK50180		1800
NP-OK50200		2000
NP-OK60140	600	1400
NP-OK60160		1600
NP-OK60180		1800
NP-OK60200		2000
NP-OK70140	700	1400
NP-OK70160		1600
NP-OK70180		1800
NP-OK70200		2000
NP-OK80140	800	1400
NP-OK80160		1600
NP-OK80180		1800
NP-OK80200		2000

ÖN KAPAK İÇERİĞİ			
FRONT DOOR CONTENT			
ÜRÜN KODU		MIKTAR	BİRİM
PRODUCT CODE		QUANTITY	UNIT
ÖN KAPAK	FRONT DOOR	1	Ad
GİZLİ MENTEŞE	HIDDEN HINGE	Max 3	Ad
KİLİT	LOCK	1	Tk
DIKEY DESTEK PROFİLİ	VERTICAL SUPPORT PROFILE	2	Ad
YATAY DESTEK PROFİLİ	HORIZONTAL SUPPORT PROFILE	Max 4	Ad

KAPAK TIPLERİ		
DOOR TYPES		
OK	DÜZ KAPAK	PLAIN DOOR
OCK	CAMLI KAPAK	GLASS DOOR
OKF	FİLTRELİ KAPAK	FILTERED DOOR
OKM	MENFEZLİ KAPAK	VENTED DOOR

KAPAK GENİŞLİĞİ 900mm VE ÜZERİ OLANLARDA KULLANILIR		
ÖN KAPAK BİNMELİ		
FRONT DOOR LOAD		
ÜRÜN KODU	EN (mm)	BOY (mm)
PRODUCT CODE	WIDTH (mm)	LENGHT (mm)
NP-OK45140B	450x1400	1400
NP-OK45140BK	450x1400	1400
NP-OK50140B	500x1400	1400
NP-OK50140BK	500x1400	1400
NP-OK55140B	550x1400	1400
NP-OK55140BK	550x1400	1400
NP-OK60140B	600x1400	1400
NP-OK60140BK	600x1400	1400
NP-OK45160B	450x1600	1600
NP-OK45160BK	450x1600	1600
NP-OK50160B	500x1600	1600
NP-OK50160BK	500x1600	1600
NP-OK55160B	550x1600	1600
NP-OK55160BK	550x1600	1600
NP-OK60160B	600x1600	1600
NP-OK60160BK	600x1600	1600
NP-OK45180B	450x1800	1800
NP-OK45180BK	450x1800	1800
NP-OK50180B	500x1800	1800
NP-OK50180BK	500x1800	1800
NP-OK55180B	550x1800	1800
NP-OK55180BK	550x1800	1800
NP-OK60180B	600x1800	1800
NP-OK60180BK	600x1800	1800
NP-OK45200B	450x2000	2000
NP-OK45200BK	450x2000	2000
NP-OK50200B	500x2000	2000
NP-OK50200BK	500x2000	2000
NP-OK55200B	550x2000	2000
NP-OK55200BK	550x2000	2000
NP-OK60200B	600x2000	2000
NP-OK60200BK	600x2000	2000

ÜST KAPAK TOP PLATE

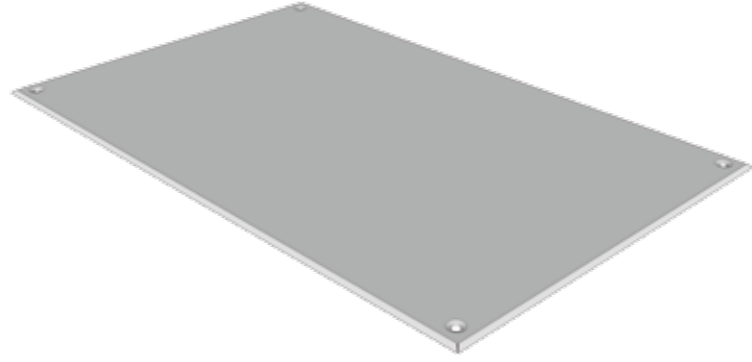

Malzeme: 1.2 mm DKP sac

IP54 koruma derecesinin sağlanması amacıyla conta ile birlikte kullanılır.

Material: 1.2 mm DKP sheet

Top plates are sealed with a gasket to provide IP54 protection degree.

ÜST KAPAK			
TOP PLATE			
ÜRÜN KODU	EN (mm)	DERİNLİK (mm)	
PRODUCT CODE	WIDTH (mm)	DEPTH (mm)	
NP-UK4040	400	400	
NP-UK4050		500	
NP-UK4060		600	
NP-UK4070		700	
NP-UK4080		800	
NP-UK4090		900	
NP-UK40100		1000	
NP-UK5040		500	400
NP-UK5050			500
NP-UK5060			600
NP-UK5070	700		
NP-UK5080	800		
NP-UK5090	900		
NP-UK50100	1000		
NP-UK06040	600		400
NP-UK06050			500
NP-UK06060			600
NP-UK06070		700	
NP-UK06080		800	
NP-UK06090		900	
NP-UK060100		1000	
NP-UK7040		700	400
NP-UK7050			500
NP-UK7060			600
NP-UK7070	700		
NP-UK7080	800		
NP-UK7090	900		
NP-UK70100	1000		
NP-UK8040	800		400
NP-UK8050			500
NP-UK8060			600
NP-UK8070		700	
NP-UK8080		800	
NP-UK8090		900	
NP-UK80100		1000	

ÜST KAPAK			
TOP PLATE			
ÜRÜN KODU	EN (mm)	DERİNLİK (mm)	
PRODUCT CODE	WIDTH (mm)	DEPTH (mm)	
NP-UK9040	900	400	
NP-UK9050		500	
NP-UK9060		600	
NP-UK9070		700	
NP-UK9080		800	
NP-UK9090		900	
NP-UK90100		1000	
NP-UK10040		1000	400
NP-UK10050			500
NP-UK10060			600
NP-UK10070	700		
NP-UK10080	800		
NP-UK10090	900		
NP-UK100100	1000		
NP-UK11040	1100		400
NP-UK11050			500
NP-UK11060			600
NP-UK11070		700	
NP-UK11080		800	
NP-UK11090		900	
NP-UK110100		1000	
NP-UK12040		1200	400
NP-UK12050			500
NP-UK12060			600
NP-UK12070	700		
NP-UK12080	800		
NP-UK12090	900		
NP-UK120100	1000		

ÜST KAPAK İÇERİĞİ			
TOP PLATE CONTENT			
ÜRÜN KODU		MİKTAR	BİRİM
PRODUCT CODE		QUANTITY	UNIT
ÜST KAPAK	TOP PLATE	1	Ad
M12 MAPA	M12 MAPA	2	Ad
M12 SOMUN	M12 NUT	2	Ad
M8 CİVATA	M8 BOLT	2	Ad
M8 SOMUN	M8 NUT	2	Ad

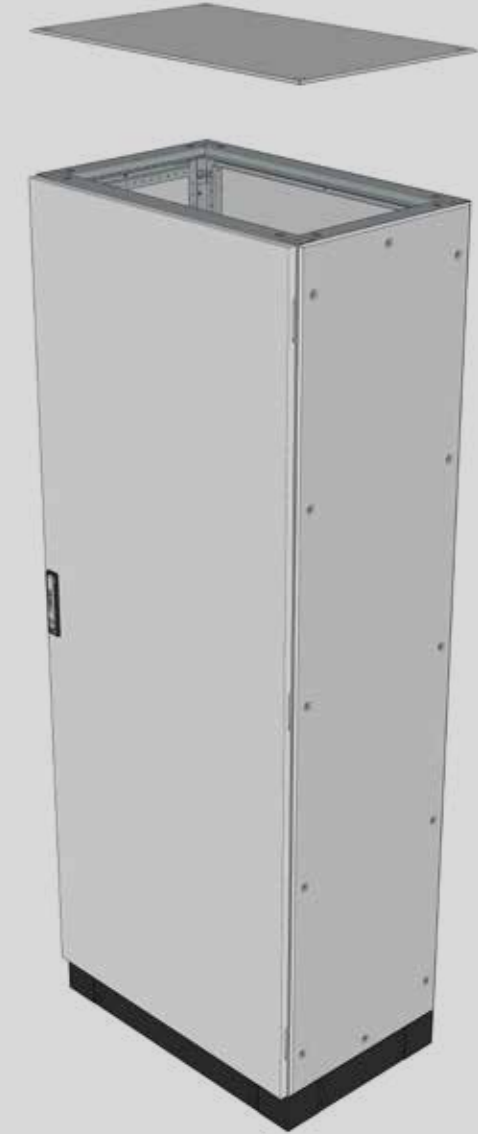



BURSA'DAN DÜNYA'YA
TÜRKİYE'NİN ELEKTRİK PANOLARI
MARKASI

360
DERECE ÇÖZÜM
360 DEGREE
SOLUTION

FROM BURSA TO THE WORLD
TURKEY'S ELECTRICAL ENCLOSURE
BRAND

BAZA TAKIMI

BASE BOARD

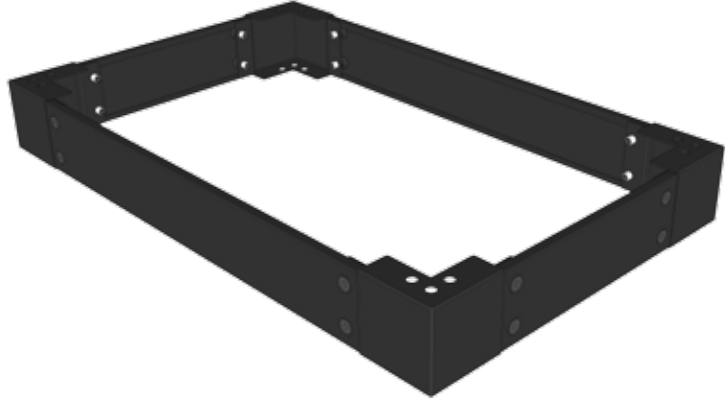

Malzeme: 2.0 mm DKP sac

Baza, 4 adet köşe ve 4 adet kapaktan oluşmaktadır.

Material: 2.0 mm DKP sheet

The base board consists of 4 corners and 4 covers.

BAZA KÖŞE	
BASE CORNER	
ÜRÜN KODU	BOY (mm)
PRODUCT CODE	LENGHT (mm)
NP-BZ100	100
NP-BZ200	200

BAZA KAPAK		
BASE COVER		
ÜRÜN KODU	EN (mm)	BOY (mm)
PRODUCT CODE	WIDTH (mm)	LENGHT (mm)
NP-BZK4010	400	100
NP-BZK4020		200
NP-BZK5010	500	100
NP-BZK5020		200
NP-BZK6010	600	100
NP-BZK6020		200
NP-BZK7010	700	100
NP-BZK7020		200
NP-BZK8010	800	100
NP-BZK8020		200
NP-BZK9010	900	100
NP-BZK9020		200
NP-BZK10010	1000	100
NP-BZK10020		200
NP-BZK11010	1100	100
NP-BZK11020		200
NP-BZK12010	1200	100
NP-BZK12020		200

BAZA TAKIM İÇERİĞİ			
BASE BOARD CONTENT			
ÜRÜN KODU		MİKTAR	BİRİM
PRODUCT CODE		QUANTITY	UNIT
BAZA KÖŞE	BASE CORNER	4	Ad
BAZA KAPAK	BASE COVER	4	Ad
M8x20 İMBUS CİVATA	BOLT IN TAPITE	16	Ad

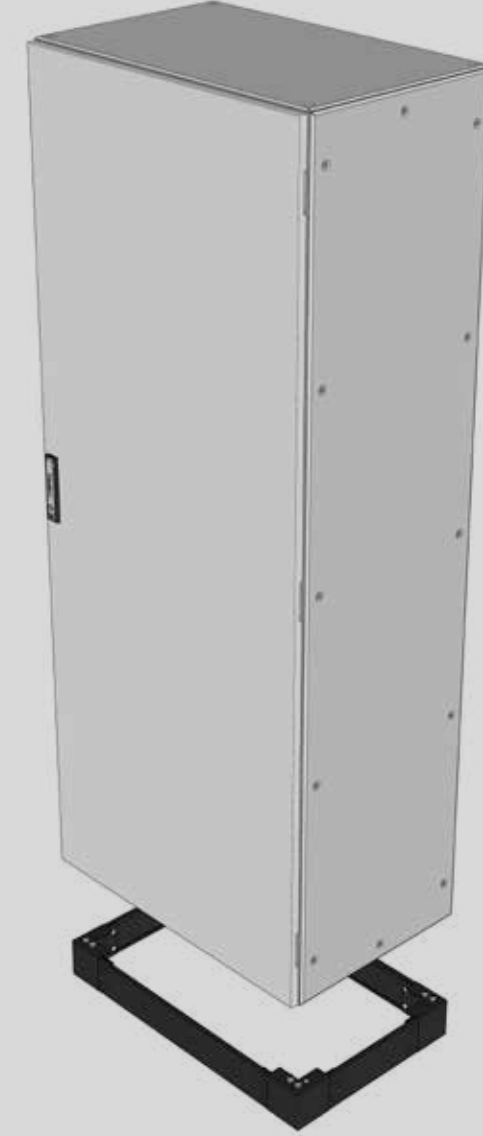

ÖRTÜ PLAKASI COVER PLATE

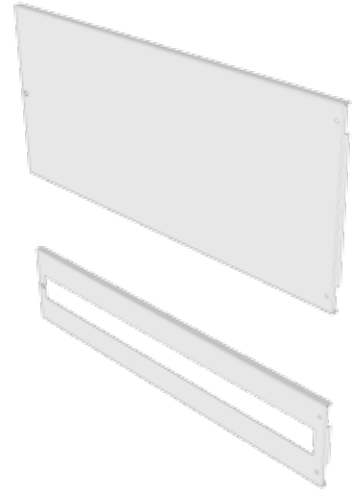

Malzeme: 1.2 mm DKP sac

Panodaki elektrik elemanlarının korunması ve görsel düzeni sağlamak için kullanılır. Ölçüler isteğe bağlı olarak imal edilebilir. Örtü plakası profilleri, örtü plakasının karkasa sabitlenmesi için kullanılır.

Material: 1.2 mm DKP sheet

Cover plates provide protect to the electrical elements and visual order in the panel. Different dimensions can be produced on request. Cover plate profiles are used for fixing the cover plate to the frame.

ÖRTÜ PLAKASI		
COVER PLATE		
ÜRÜN KODU	EN (mm)	BOY (mm)
PRODUCT CODE	WIDTH (mm)	LENGHT (mm)
NP-MDOP405	400	50
NP-MDOP4010		100
NP-MDOP4015		150
NP-MDOP4015A		150
NP-MDOP4015F		150
NP-MDOP4020		200
NP-MDOP4025		250
NP-MDOP4030		300
NP-MDOP4035		350
NP-MDOP4040		400
NP-MDOP4045		450
NP-MDOP4050		500
NP-MDOP4055		550
NP-MDOP4060		600
NP-MDOP505	500	50
NP-MDOP5010		100
NP-MDOP5015		150
NP-MDOP5015A		150
NP-MDOP5015F		150
NP-MDOP5020		200
NP-MDOP5025		250
NP-MDOP5030		300
NP-MDOP5035		350
NP-MDOP5040		400
NP-MDOP5045		450
NP-MDOP5050		500
NP-MDOP5055		550
NP-MDOP5060		600
NP-MDOP605	600	50
NP-MDOP6010		100
NP-MDOP6015		150
NP-MDOP6015A		150
NP-MDOP6015F		150
NP-MDOP6020		200
NP-MDOP6025		250
NP-MDOP6030		300
NP-MDOP6035		350
NP-MDOP6040		400
NP-MDOP6045		450
NP-MDOP6050		500
NP-MDOP6055		550
NP-MDOP6060		600

ÖRTÜ PLAKASI		
COVER PLATE		
ÜRÜN KODU	EN (mm)	BOY (mm)
PRODUCT CODE	WIDTH (mm)	LENGHT (mm)
NP-MDOP705	700	50
NP-MDOP7010		100
NP-MDOP7015		150
NP-MDOP7015A		150
NP-MDOP7015F		150
NP-MDOP7020		200
NP-MDOP7025		250
NP-MDOP7030		300
NP-MDOP7035		350
NP-MDOP7040		400
NP-MDOP7045		450
NP-MDOP7050		500
NP-MDOP7055		550
NP-MDOP7060		600
NP-MDOP805	800	50
NP-MDOP8010		100
NP-MDOP8015		150
NP-MDOP8015A		150
NP-MDOP8015F		150
NP-MDOP8020		200
NP-MDOP8025		250
NP-MDOP8030		300
NP-MDOP8035		350
NP-MDOP8040		400
NP-MDOP8045		450
NP-MDOP8050		500
NP-MDOP8055		550
NP-MDOP8060		600
NP-MDOP905	900	50
NP-MDOP9010		100
NP-MDOP9015		150
NP-MDOP9015A		150
NP-MDOP9015F		150
NP-MDOP9020		200
NP-MDOP9025		250
NP-MDOP9030		300
NP-MDOP9035		350
NP-MDOP9040		400
NP-MDOP9045		450
NP-MDOP9050		500
NP-MDOP9055		550
NP-MDOP9060		600

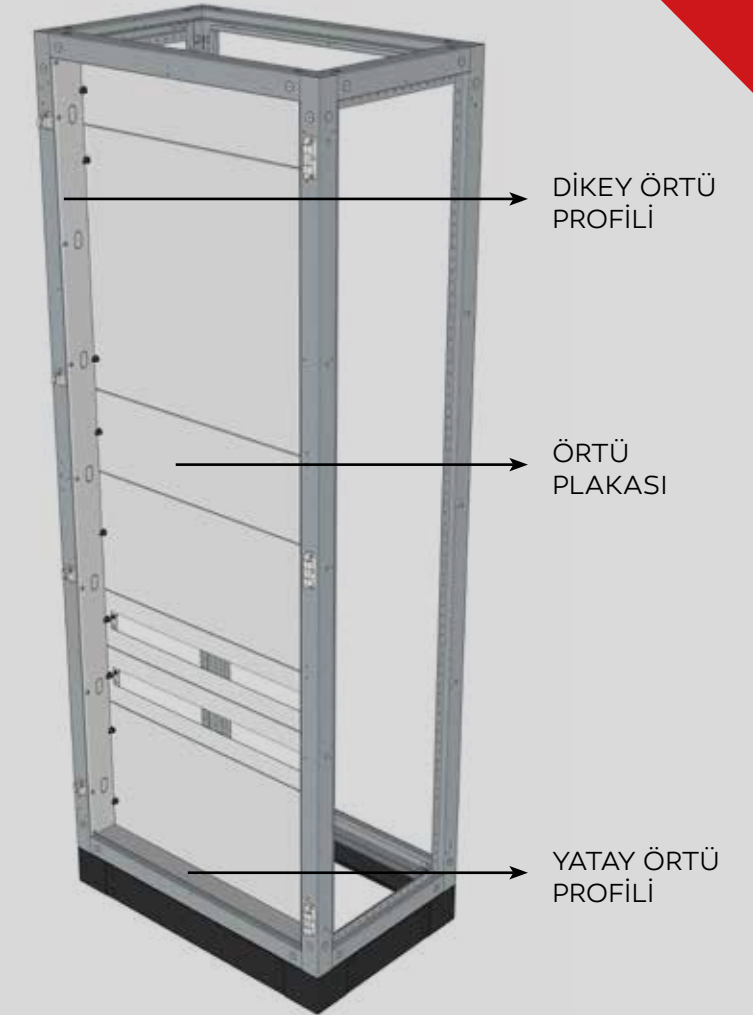

DIKEY ÖRTÜ PROFİLİ

ÖRTÜ PLAKASI

YATAY ÖRTÜ PROFİLİ

DIKEY ÖRTÜ PROFİLİ	
VERTICAL COVER PROFILE	
ÜRÜN KODU	BOY (mm)
PRODUCT CODE	LENGHT (mm)
NP-DOP1400	1400
NP-DOP1600	1600
NP-DOP1800	1800
NP-DOP2000	2000

YATAY ÖRTÜ PROFİLİ	
HORIZONTAL COVER PROFILE	
ÜRÜN KODU	EN (mm)
PRODUCT CODE	WIDTH (mm)
NP-YOP400	400
NP-YOP500	500
NP-YOP600	600
NP-YOP700	700
NP-YOP800	800
NP-YOP900	900

KALİTEMİZİN PUSULASI, EĞİTİMİ GÖSTERİYOR!

THE COMPASS OF OUR QUALITY INDICATES EDUCATION

Mükemmeli hedefleyen kalite yolculuğumuzda
en büyük gücümüz "İnsan Kaynaklarımız"

*Our biggest strength in our quality journey aiming for
perfection is our "Human Values"*

Kalitede
mükemmeli
hedefliyoruz

*We aim for
excellence
in quality*

- 1 KESİNTİSİZ HİZMET İÇİ EĞİTİM**
CONTINUOUS IN-SERVICE TRAINING
- 2 SPESİFİK PROGRAMLAR**
SPECIFIC PROGRAMS
- 3 DOĞRU İŞ GÜVENLİĞİ VE İŞÇİ SAĞLIĞI**
CORRECT OCCUPATIONAL SAFETY AND WORKER HEALTH
- 4 YENİLİKÇİ TEKNOLOJİLER**
INNOVATIVE TECHNOLOGIES

ALT ÖRTÜ PLAKASI

BOTTOM COVER PLATE



Malzeme: 1.2 mm galvanizli sac

Panonun alt kısmında görsel düzeni sağlar. Ayrıca panoyu alttan girebilecek olan tozlara karşı korur.

Material: 1.2mm galvanized sheet

Provides visual layout at the bottom of the board. It also protects the panel against dust.

ALT ÖRTÜ PLAKASI	
BOTTOM COVER PLATE	
ÜRÜN KODU	EN (mm)
PRODUCT CODE	WIDTH (mm)
NP-AOP40	400
NP-AOP50	500
NP-AOP60	600
NP-AOP70	700
NP-AOP80	800
NP-AOP90	900
NP-AOP100	1000
NP-AOP110	1100
NP-AOP120	1200

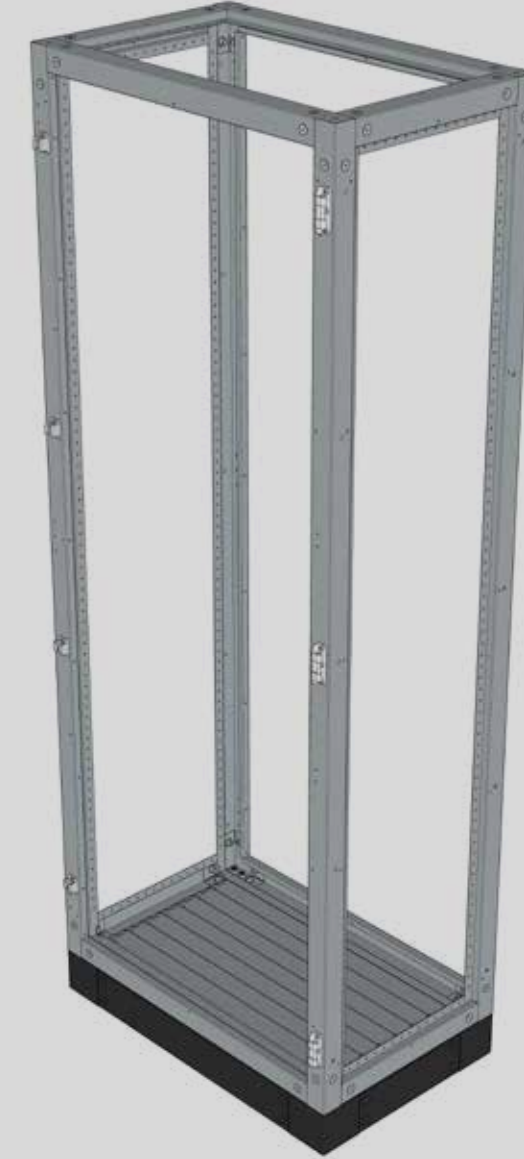

MONTAJ PLAKASI

MOUNTING PLATE



Malzeme: 2.0 mm galvanizli sac

Montaj plakası, panonun arkasına veya yanlarına monte edilerek, derinlik ayarını ve panonun tüm elektrik ekipmanları arasındaki bağlantıyı sağlar. Montaj plakası, modüler karkasa M6x15 civata ile monte edilmektedir. Tüm kenarlar bükülerek mukavemet arttırılmıştır. Montaj plakası istenen derinlik pozisyonunda ayarlanabilir. Montaj plakası çeşitleri: Tam boy ve parçalı montaj plakası

Material: 2.0mm galvanized sheet

The mounting plate is mounted on the back or sides of the panel, providing depth adjustment and connection between all electrical equipment of the panel. The plate is fixed to the frame with M6x15 bolts. Strength is increased by bending all edges. The mounting plate can be adjusted to any depth position.

Mounting plate types: Full-length and partial mounting plate

TAM BOY MONTAJ SACI		
FULL LENGTH ASSEMBLY SHEET		
ÜRÜN KODU	EN (mm)	BOY (mm)
PRODUCT CODE	WIDTH (mm)	LENGHT (mm)
NP-MDBMP40140	400	1400
NP-MDBMP40160		1600
NP-MDBMP40180		1800
NP-MDBMP40200		2000
NP-MDBMP50140	500	1400
NP-MDBMP50160		1600
NP-MDBMP50180		1800
NP-MDBMP50200		2000
NP-MDBMP60140	600	1400
NP-MDBMP60160		1600
NP-MDBMP60180		1800
NP-MDBMP60200		2000
NP-MDBMP70140	700	1400
NP-MDBMP70160		1600
NP-MDBMP70180		1800
NP-MDBMP70200		2000
NP-MDBMP80140	800	1400
NP-MDBMP80160		1600
NP-MDBMP80180		1800
NP-MDBMP80200		2000
NP-MDBMP90140	900	1400
NP-MDBMP90160		1600
NP-MDBMP90180		1800
NP-MDBMP90200		2000
NP-MDBMP100140	1000	1400
NP-MDBMP100160		1600
NP-MDBMP100180		1800
NP-MDBMP100200		2000
NP-MDBMP110140	1100	1400
NP-MDBMP110160		1600
NP-MDBMP110180		1800
NP-MDBMP110200		2000
NP-MDBMP120140	1200	1400
NP-MDBMP120160		1600
NP-MDBMP120180		1800
NP-MDBMP120200		2000

PARÇALI MONTAJ SACI		
PIECE ASSEMBLY SHEET		
ÜRÜN KODU	EN (mm)	BOY (mm)
PRODUCT CODE	WIDTH (mm)	LENGHT (mm)
NP-MDPMP4010	400	100
NP-MDPMP4015		150
NP-MDPMP4020		200
NP-MDPMP4025		250
NP-MDPMP4030		300
NP-MDPMP4035		350
NP-MDPMP4040		400
NP-MDPMP4045		450
NP-MDPMP4050		500
NP-MDPMP4055		550
NP-MDPMP4060	500	600
NP-MDPMP4065		650
NP-MDPMP4070		700
NP-MDPMP5010		100
NP-MDPMP5015		150
NP-MDPMP5020		200
NP-MDPMP5025		250
NP-MDPMP5030		300
NP-MDPMP5035		350
NP-MDPMP5040		400
NP-MDPMP5045	450	
NP-MDPMP5050	500	
NP-MDPMP5055	550	
NP-MDPMP5060	600	
NP-MDPMP5065	650	
NP-MDPMP5070	700	
NP-MDPMP6010	600	100
NP-MDPMP6015		150
NP-MDPMP6020		200
NP-MDPMP6025		250
NP-MDPMP6030		300
NP-MDPMP6035		350
NP-MDPMP6040		400
NP-MDPMP6045		450
NP-MDPMP6050		500
NP-MDPMP6055		550
NP-MDPMP6060	600	
NP-MDPMP6065	650	
NP-MDPMP6070	700	

PARÇALI MONTAJ SACI		
PIECE ASSEMBLY SHEET		
ÜRÜN KODU	EN (mm)	BOY (mm)
PRODUCT CODE	WIDTH (mm)	LENGHT (mm)
NP-MDPMP7010	700	100
NP-MDPMP7015		150
NP-MDPMP7020		200
NP-MDPMP7025		250
NP-MDPMP7030		300
NP-MDPMP7035		350
NP-MDPMP7040		400
NP-MDPMP7045		450
NP-MDPMP7050		500
NP-MDPMP7055		550
NP-MDPMP7060	800	600
NP-MDPMP7065		650
NP-MDPMP7070		700
NP-MDPMP8010		100
NP-MDPMP8015		150
NP-MDPMP8020		200
NP-MDPMP8025		250
NP-MDPMP8030		300
NP-MDPMP8035		350
NP-MDPMP8040		400
NP-MDPMP8045	450	
NP-MDPMP8050	500	
NP-MDPMP8055	550	
NP-MDPMP8060	600	
NP-MDPMP8065	650	
NP-MDPMP8070	700	
NP-MDPMP9010	900	100
NP-MDPMP9015		150
NP-MDPMP9020		200
NP-MDPMP9025		250
NP-MDPMP9030		300
NP-MDPMP9035		350
NP-MDPMP9040		400
NP-MDPMP9045		450
NP-MDPMP9050		500
NP-MDPMP9055		550
NP-MDPMP9060	600	
NP-MDPMP9065	650	
NP-MDPMP9070	700	

PARÇALI MONTAJ SACI İÇERİĞİ			
PIECE ASSEMBLY SHEET CONTENT			
ÜRÜN KODU		MIKTAR	BİRİM
PRODUCT CODE		QUANTITY	UNIT
PARÇALI MONTAJ SACI	PIECE ASSEMBLY SHEET	1	Ad
L BRACKET	L BRACKET	Min 2	Ad
M5x12 TATITE CIVATA	BOLT IN TAPITE	Min 4	Ad

MONTAJ SACI İÇERİĞİ			
ASSEMBLY SHEET CONTENT			
ÜRÜN KODU		MIKTAR	BİRİM
PRODUCT CODE		QUANTITY	UNIT
MONTAJ SACI	ASSEMBLY SHEET	1	Ad
MONTAJ SACI DERİNLİK KIZAĞI	ASSEMBLY SHEET DEPTH SLIDE	2	Ad
MONTAJ SACI BRAKETİ	ASSEMBLY SHEET BRACKET	4	Ad
M6x15 YSB CIVATA TAKIMI	M6x15 YSB BOLT SET	8	Ad
M5x12 TATITE CIVATA	BOLT IN TAPITE	20	Ad

MONOBLOK PANOLAR

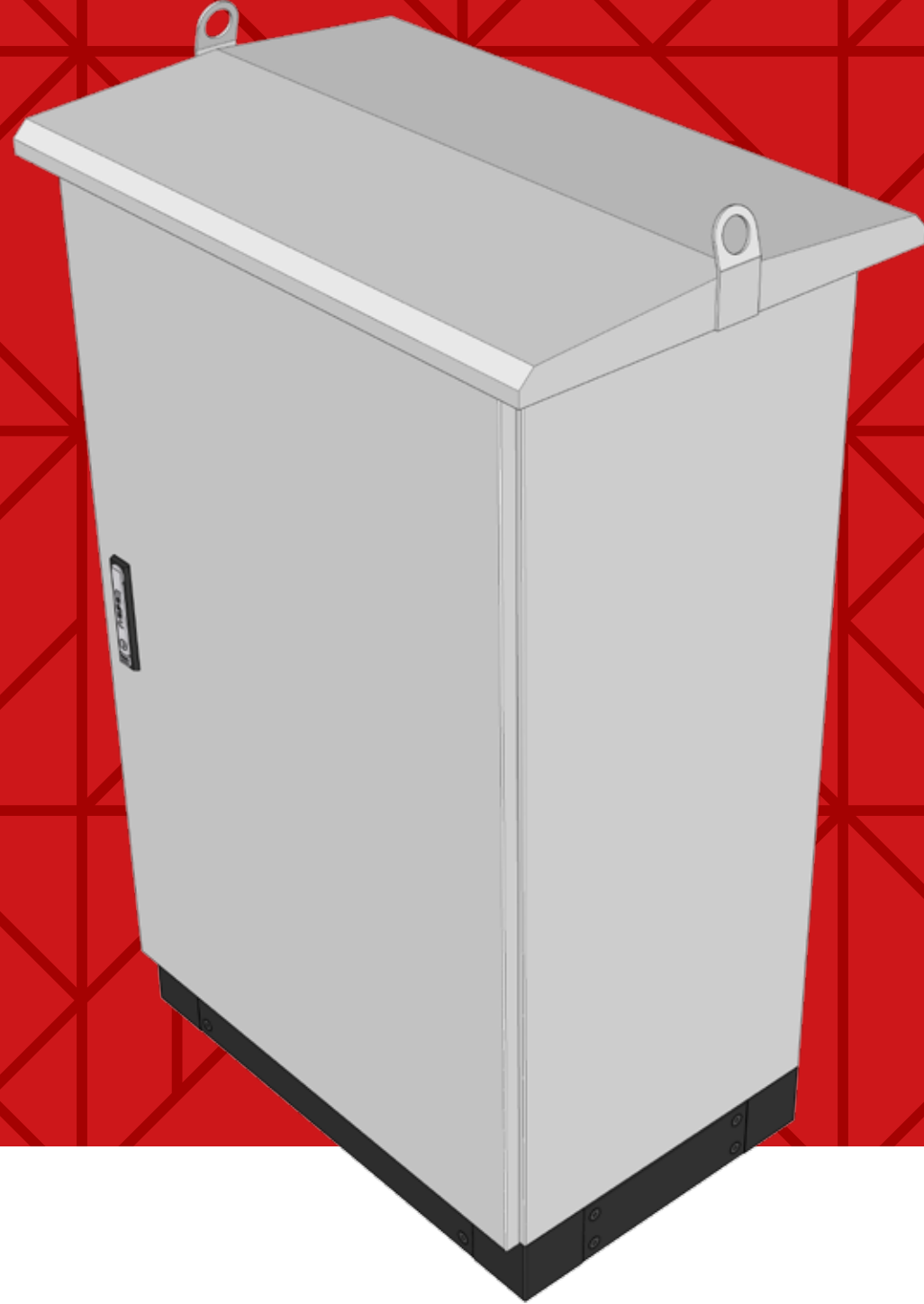

HARİCİ SAYAÇ PANOLARI *OUTDOOR GABLE ROOF WALL-MOUNT ENCLOSURE COUNTER PANELS*

50 kVA - 400 kVA Arası harici tip trafo çıkış ve sayaç panoları.
Outdoor type transformer output and counter panels



HARİCİ DAĞITIM PANOLARI *OUTDOOR GABLE ROOF WALL-MOUNT ENCLOSURE DISTRIBUTION PANELS*

50 kVA - 400 kVA Arası harici tip kuvvet dağıtım panoları.
Outdoor type power distribution panels



HARİCİ SAYAÇ VE DAĞITIM PANOLARI

Outdoor Gable Roof Wall-Mount Enclosures Counter and Distribution Panels

50 kVA - 400 kVA Arası harici tip trafo çıkış, sayaç ve kuvvet kompanzasyon panoları.

External type transformer output, counter and power compensation panels



SIVA ÜSTÜ DAĞITIM PANOLARI

Wall Mount Distribution Enclosures



EN (mm)	BOY (mm)	DERİNLİK (mm)
WIDTH (mm)	LENGHT (mm)	DEPTH (mm)
300	300	150
400	600	
600	800	
800	1000	
800	1200	

EN (mm)	BOY (mm)	DERİNLİK (mm)
WIDTH (mm)	LENGHT (mm)	DEPTH (mm)
300	300	250
400	600	
600	800	
800	1000	
800	1200	

EN (mm)	BOY (mm)	DERİNLİK (mm)
WIDTH (mm)	LENGHT (mm)	DEPTH (mm)
300	300	300
400	600	
600	800	
800	1000	
800	1200	

SIVA ALTI DAĞITIM PANOLARI

Flush Mount Distribution Enclosures

Standart veya projeye özel siva altı dağıtım panoları.

Standard or customized flush mount distribution enclosures

EN (mm)	BOY (mm)	DERİNLİK (mm)
WIDTH (mm)	LENGHT (mm)	DEPTH (mm)
300	300	150
400	600	
600	800	
800	1000	
800	1200	



ŞANTIYE PRİZ PANOLARI

*Outdoor Gable Roof Wall-Mount Encloser
Construction site socket panels*

Projeye özel şantiye priz panoları. *Project-specific construction site socket panels*





KİLİT / LOCK

İspanyolet kilit ile 4 noktadan kilitleme sağlanmaktadır.

Locking from 4 points is provided with espagnolette lock.



BOYA PAINTING

Standart RAL7035 elektrostatik toz boya kullanılmaktadır. Özel istek üzerinde farklı renkler uygulanabilir.

Standard RAL7035 electrostatic powder coating is used. Different colors can be applied on special request.

EK AKSESUARLAR / ADDITIONAL ACCESSORIES

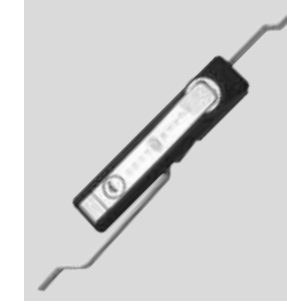

Kilit mekanizması
Rod latch system

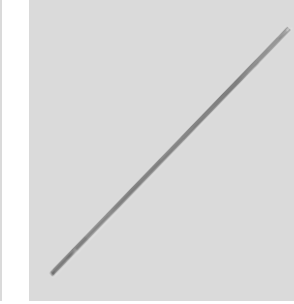

İspanyolet kilit çubuğu
Espagnolette Rod Lock



Lama yatağı
Flat rod guide



Gizli Menteşe
Concealed Hinge



Örtü Plakası Menteşesi
Örtü Plakası Menteşesi



Kaldırma mapası
Lifting eyebolt



İmbus Cıvata
Socket cap screw



Kafes Somun
Cage Nut



Taptite Cıvata
Taptite Screw



BURSA'DAN DÜNYA'YA
TÜRKİYE'NİN ELEKTRİK PANOLARI
MARKASI

360
DERECE ÇÖZÜM
*360 DEGREE
SOLUTION*

FROM BURSA TO THE WORLD
TURKEY'S ELECTRICAL ENCLOSURE
BRAND



BURSA - TÜRKİYE

0224 **443 55 48** | www.neserpano.com.tr

proje@neserpano.com.tr